



AirLock Enclosure Systems



LATCH-TOGETHER

CLEANROOM SYSTEMS FOR

FAST INSTALLATION



 **SIMPLEX**[™]
ISOLATION SYSTEMS

Expect a Full Measure of Quality.



Simplex AirLock Enclosure Systems are quality enclosures that help to protect against airborne contaminants, ultraviolet rays and temperature fluctuations. AirLock Modular Enclosures are designed, engineered and manufactured to offer great flexibility.

They will expand, change or reconfigure easily to accommodate evolving requirements.

They adapt to a variety of filtration systems and lighting configurations.

They accept a wide variety of wall materials including soft clear vinyl, colored and anti-static vinyl, rigid ABS sheets, Lexan®, acrylic, screens and even aluminum panels.

At Simplex we are always looking for innovative solutions that will help our customers control their cleanroom environments. You can count on Simplex Isolation Systems to give you high quality modular cleanrooms that are efficient, convenient and lead the way in modular cleanroom technology.

In addition, Simplex's AirLock latch-together technology makes the process of assembly or disassembly surprisingly easy. Our cleanrooms can be completely disassembled and stored, expanded or reconfigured by adding or subtracting AirLock's latch-together, lightweight modular sections.

AirLock modular cleanrooms meet the new ISO 14644-1 classifications for ISO Class 8 (Class 100,000) to ISO Class 4 (Class 10) and can be custom designed to meet your particular application.



With AirLock from Simplex you can assemble a functional 10' x 10' cleanroom in less than one hour.

AirLock Offers Many Uses

Hospitals and Health Care - Use AirLock for infectious disease control, inhalation and treatment rooms, in both positive and negative pressure environments. Simplex ultra-violet vinyls protect light-sensitive laboratory experiments.

Semiconductor Manufacturing - From mini-environments to large, self-contained cleanrooms, AirLock can provide a room of any size and classification. AirLock is designed to keep assembly areas free of contaminants and dust. Static-free and non-outgassing materials are also available.

Industrial and Manufacturing - Use AirLock to create machinery enclosures. Excellent for welding operations, laser procedures, paint operations and sound booths.

Medical Device and Pharmaceutical Manufacturing - Use AirLock for process isolation to prevent cross contamination and control humidity and temperature. AirLock can be adapted for ISO Class 8 (Class 100,000) to ISO Class 4 (Class 10) cleanrooms with positive or negative pressure.

Hazardous Materials - Set up area isolation for emergency toxic waste cleanup and HazMat handling.

Food and Beverage Preparation - AirLock adapts to virtually any configuration, including assembly lines and packaging. AirLock walls and anodized aluminum frames wash down quickly and easily.



Hospitals and Health Care



Medical Device/
Pharmaceutical
Manufacturing



Hazardous
Materials



Semiconductor
Manufacturing



Industrial and
Manufacturing



Food and Beverage
Preparation

ENCLOSURE MODELS 150/250

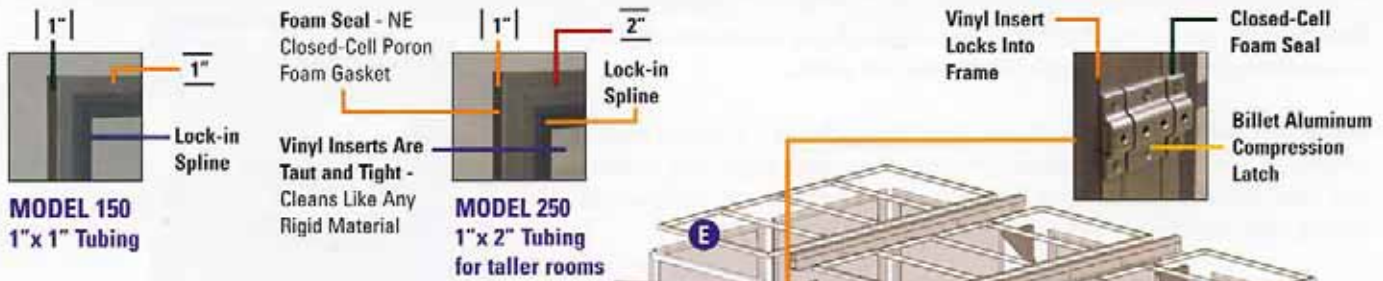

- A** Neoprene closed-cell foam gaskets seal frame-to-frame connections.
- B** Insert materials lock into frame with an airtight seal; inserts cannot be knocked loose from accidental impacts. Cleaning is quick and easy.
- C** Frame construction with knock-together corners allows for replacement of individual parts.
- D** Numerous door options to accommodate individual uses; pre-hung for quick assembly.
- E** Ceiling frames with integrated 2" T-grid in 2'x4' standard openings latch into position in the same manner as the walls. The 2' x 4' openings can accommodate various types of filtration and lighting units.
- F** Lightweight aluminum frames are available in anodized clearcoat. Epoxy powder-coated frames are available.

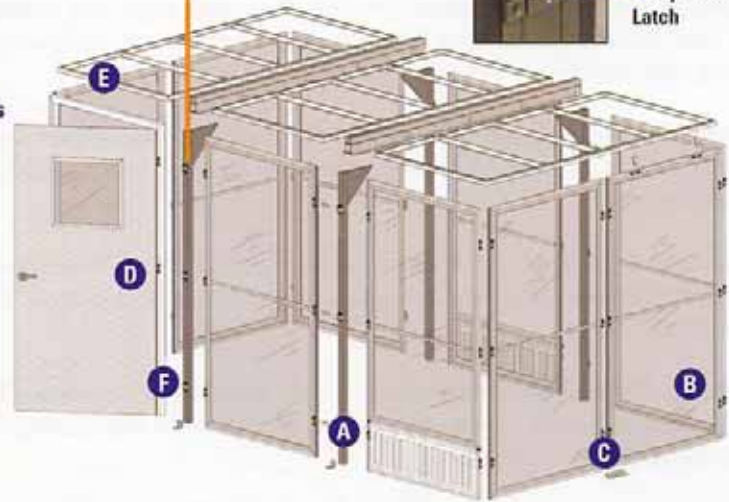

Basic Construction Features

AirLock cleanrooms assemble quickly with minimal use of tools! Many applications can be assembled in less than one hour. The latch-together system provides strong, positive connection at walls, corners, ceilings - virtually every connection. Because of the modular design, AirLock enclosures are equally effective in both permanent and temporary applications. They can be easily expanded or reconfigured to meet ever-changing demands.

Wall Panel Insert Options



AirLock's simple locking system means that panels install and remove easily.

AirLock wall panels are available in many types of materials in many combinations.

OPTIONS:

- 50-50 walls feature clear tops with opaque color bottoms.
- Thicknesses include .040, .060, .080 and .120 mils.
- Panel options include standard vinyl, static dissipative and PolySim™ non-outgassing, static dissipative vinyl.
- Colors include clear, frosted, amber tint, grey smoke tint, and opaque colors - blue, grey, white, black and tan.
- 1/8" thick acrylic and polycarbonate panels available in clear and many colors, as well as scratch resistant and anti-static coatings.
- Rigid PVC and ABS panels in various textures and colors.
- Laminated aluminum panels come in 1/8" and 1/4" thicknesses with various coating options.
- Polycarbonate thermo-insulated 1/4" insulated panels.
- SoundBlock™ insulated vinyl panels.

AirLock doors are pre-hung in their frames for quick and easy installation and are available in the same material as the AirLock walls.

Single and Double-framed ABS and Vinyl Swing Doors - Features include continuous airtight gear hinges for effortless movement, lever door handles, and foam seals to ensure complete closure. Options include handles with locking mechanisms and hydraulic closers.

Sliding Doors - Available in single and double panels with anodized aluminum roller track, and magnetic and vinyl sweep seals. Option includes automatic closing device.

Strip Door - Available in many widths, thicknesses and colors. Features the exclusive Simplex clear/frost non-stick design for easy personnel and equipment passage.

Bi-folding Curtain - Available with anodized aluminum or stainless steel track. Options include various thicknesses and materials and a choice of magnetic or dual lock closers.

Dual-Flex Door - Flexible vinyl panels with spring-loaded or gravity hinges. Designed to allow 180 degree movement. Available in various colors, materials and thicknesses.



ABS Single Swing Door



Vinyl Single Swing Door



Double Swing Door



Sliding Door



Strip Door



Dual-Flex Door

Venting Options

Simplex offers several different types of air venting and exhaust systems for either positive or negative pressure rooms.



Screen Mesh - Vinyl coated, non-particulating. Standard on all vinyl inserts.



ABS Adjustable Sliding Grill - Can be adjusted to accommodate air flow requirements.



Open Air Space - Framed open air space available with vinyl flap to seal opening when room is not pressurized.



Pre-filter - Attaches with dual lock closers for easy replacement.



PVC Shutters - Open automatically when room is pressurized.



Floor Cleats secure AirLock cleanroom structures firmly to the floor and ensure a proper seal.

To insure a proper seal and safe operation of your AirLock cleanroom all walls should be attached securely to the floor. AirLock features several different attachment systems, all of which can be installed temporarily using structural adhesive foam tape or permanently by bolting to existing floors.

FLOOR ATTACHMENTS

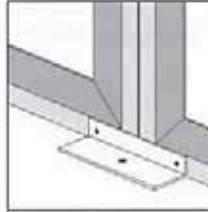

Floor Cleats - Installed at all joints of walls on one or both sides of the floor.

WALL & CEILING ATTACHMENTS

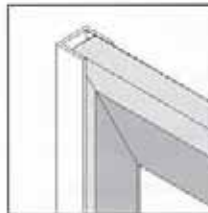

U-track - Installs on walls, holding panels in place.

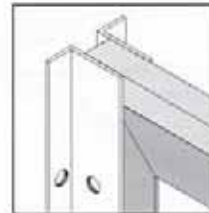

Angle Fasteners - Can be installed on inside or outside of walls, or both if desired.

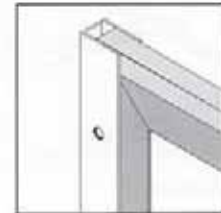

Angle and Face Plate - Allows wall to be fastened to existing wall with face plate covering gaps for cleanliness.

Dividers and Wall Systems Models 100/200

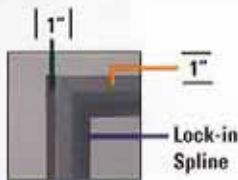

MODEL 100
1"x 1" Tubing

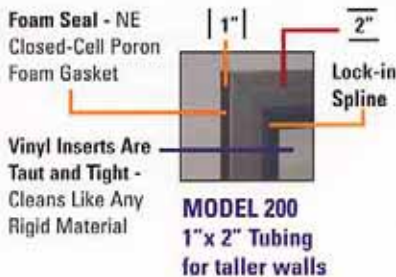

MODEL 200
1"x 2" Tubing
for taller walls

AirLock wall panels can be used to divide existing rooms or create rooms utilizing existing suspended ceilings. They attach easily and secure to existing ceilings, floors and walls with various Simplex wall fastening systems. This system offers an economical and attractive alternative to high cost construction that often requires permits. AirLock walls can also be designed as permanent or moveable walls for use as safety or privacy screens.



Free-stand panels can serve as privacy screens or safety dividers. Black panels confine laser procedures. Amber confines welding procedures.

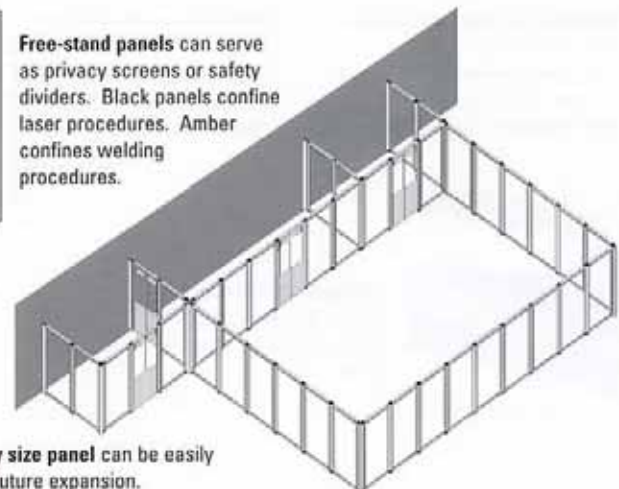

Wall divisions of any size panel can be easily moved or added for future expansion.

Greater Strength, Larger Rooms

The standard AirLock ceiling is a fully integrated 2" T-bar. When assembling pre-fabricated modules, simply set the ceiling assembly onto the room and latch it down. Ceiling accepts standard 2' x 4' ceiling tiles and components. Ceiling options include all-vinyl ceilings in both clear and colored materials, as well as framed openings for HEPAs and lights.

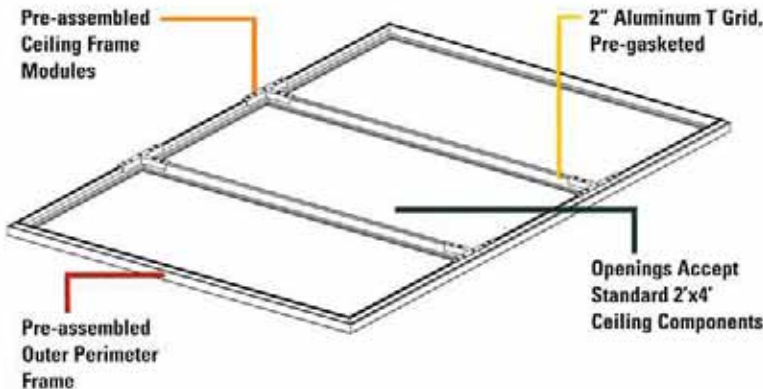

The standard AirLock suspended ceiling structure can accommodate limited, medium and heavy ceiling load needs. The module frame components are structurally designed for easy assembly and able to adapt to various room configurations.

Ceiling Support Options



Medium-duty aluminum support struts measuring 2" x 4" are integrated between ceiling panels for room widths up to 16 feet wide with limited ceiling loads.



Stiffeners can be added to aluminum struts measuring 2" x 4" to accommodate larger rooms up to 18 feet wide with larger ceiling loads.



Heavy-duty truss systems can be added to standard struts to accommodate spans up to 21 feet wide and heavier ceiling loads.



Threaded rod suspenders support ceiling frames or struts from any existing structure above for larger rooms of any size. Ceiling loads are limited only by the number of attachments and the strength of the existing ceiling.



Ceiling to Strut Connector is used to connect existing ceiling frames to standard struts.



Dual-Pane telescoping windows allow you to build a quality cleanroom in a minimal amount of space.

Standard Sizes: Height 7'-9', 8'-12'
Width 2', 3', 4', and 5'

Door Modules With Strips, Bi-fold Curtains and Frame Swing Doors are available.



The Dual-Pane telescoping panels expand from seven to as large as nine feet in seconds, using a compression latch locking mechanism. Custom widths and heights are also available.

Telescopes Easily To Fit Existing Ceilings.

Dual-Pane™ telescoping walls are designed for temporary isolation enclosures and dividers. They are ideal for maintenance work within functioning cleanrooms. They are lightweight and set up in seconds. Double-sweep seals between sliding frames and closed-cell gasketing ensure additional seals. Custom heights, frame finishes, gasketing and latches are available for different applications.

FEATURES:

- Quarter-inch closed-cell foam conforms to ceiling for airtight fit.
- Chemical resistant neoprene seal creates airtight seal on sides.
- Vinyl sweep maintains seal between panes.
- Easy-to-operate compression latches secure panes.
- A simple twist of locking knobs adjusts panels from 7' to 9' high in seconds.
- Vinyl panels snap into frame for an airtight seal (other materials available).
- Durable, lightweight, anodized aluminum frame.



Corner Seal



Foot with Leveler

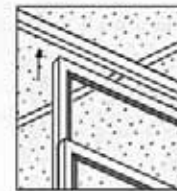

C-Channel Ceiling Attachment

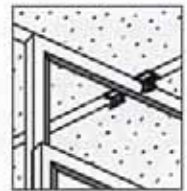

T-Grid Ceiling Attachment

Options And Accessories For AirLock Projects



Flange glove or exhaust ports can be easily adapted to system.

WALL ACCESSORIES OPTIONS:

- Glove ports
- Pass-throughs
- Sliding or swinging access panels
- Shelving
- Equipment access ports
- Portable transportation carts
- Strip conveyor openings
- Epoxy powder-coated framing



AirLock transportation carts, designed for safe and easy transportation of AirLock panels, can be custom sized to fit your factory doorways.

AirLock rooms and enclosures can be designed in all shapes and sizes, configured with internal and external anterooms or dividers. The possibilities are endless!



Plenum Rooms



Mini-environments



Industrial Applications



Production Showrooms,
Tradeshow Displays

Architectural Specifications

Wall and Ceiling Panels

Panels shall be fabricated for fast, clean installation; modular and interchangeable for future expansion. Frames are extruded 1" tubing 6063-T5 clear finished anodized aluminum or epoxy powder-coated white. Frame shall interconnect using compression tongue latches unless otherwise specified.

Panel inserts are standard .040 mil, optically clear flexible vinyl, installed using a fully gasketed Simplex bonded hook-bead system to provide an airtight seal. Other types of wall inserts available. Refer to page 2 for additional information.

Flame retardancy meets UL 94 V-0 and NFPA 701 flame test criteria. Some insert panel materials will meet more stringent flame tests. Consult with factory for your requirements.

Structural Posts

Shall be extruded 6063-T5 clear finished anodized aluminum. Posts function as corner connectors for wall panels and as supports for ceiling joists. Posts also designed to serve as raceways for electrical, computer and telephone cable lines.

Doors and Frames

Shall be pre-hung in frames extruded from 6063-T5 clear finished anodized aluminum and/or epoxy powder-coated finishes. Many types of doors are available. Refer to door section on page 3.

Warranty

Simplex Warranty

Simplex warrants their products to be free of manufacturing defects and against product failure of any kind for a period of one year from date of shipment. This includes premature yellowing or curling of strips (excluding those components that do not have UV protection - see sales rep for details). This warranty is limited to the repair or replacement of vinyl strips, vinyl panels or softwall materials and/or attaching hardware, and does not include damage resulting from accident or malicious misuse. This warranty further applies only when the recommended material thickness and width are used for the originally specified application. Further, it applies only to Simplex doors, softwalls or frame systems which are properly installed in accordance with Simplex installation instructions. Additional extended warranty may be available on certain applications. See individual application sheets or ask your representative. ARMOR-BOND lifetime guarantee applies to first 3 inches of strip where stress is the greatest and attaches to the mounting hardware. Remainder of strip applies to 1 year warranty.



Expect a Full Measure of Quality.



Simplex Strip Doors, Inc.
14500 Miller Ave.
Fontana, CA 92338
Toll Free: 800 854-7951
FAX: 909 429-0217

website: simplexisolationssystem.com
e-mail: simplexstripdoors@att.net

Southeast Region
Toll Free: 800 692-4378
FAX: 828 859-5828

Northeast Region
Toll Free: 877 746-7540
FAX: 781 982-0978

Distributed By